



- Shaft Copying Systems
- Incremental Encoders
- Absolute Encoders
- Bearingless Encoders

With precision and optimum travel comfort to your destination

Elevators are among the safest means of transport in the world. Over one billion people trust this technology to quickly and, above all, safely reach their destination comfortably. Sensors play an important role here. Drive and control manufacturers and elevator builders have relied on Kübler for years.

Encoders and bearingless encoders for optimally controlling the drive as well as shaft copying systems for absolute positioning of the elevator car are in use around the world in countless elevators. So you too can trust our sensors and our many years of experience. When will you choose Kübler?



Contents

Solutions for Elevator Technology

| | |
|---|---|
| Precision, safe positioning of the elevator car | 4 |
| Optimum control of the drive | 5 |

Shaft Copying Systems

| | |
|---|----|
| Conventional elevator system | 6 |
| Modern elevator system | 7 |
| Elevator and safety functions according to EN 81-20/21/50 | 8 |
| Portfolio overview – Ants shaft copying systems | 10 |
| The overall system at a glance | 11 |
| Overview of individual assembly steps | 12 |
| Your benefits with Ants shaft copying systems | 14 |

Encoders for Elevator Technology

| | |
|---|----|
| Encoders for gearless drives | 16 |
| Bearingless encoders for pancake drives | 20 |
| Encoders for geared motors | 22 |

Electrical Interfaces

| | |
|--------------------------------|----|
| Overview electrical interfaces | 24 |
| BiSS interface | 26 |

Company

| | |
|---|----|
| Product portfolio – Made in Germany | 28 |
| Kübler service for worldwide planning reliability | 29 |

Precision, safe positioning of the elevator car with Ants shaft copying systems

Elevators are considered the safest means of transport in the world. Entry into force of the new elevator standards EN 81-20, EN 81-21 and EN 81-50 will further improve the already high safety standard for elevators. This means greater overall safety for passengers, fitters and service personnel. Digital shaft copying systems play an important role in this. Kübler offers the right solution for every type of elevator.

Measurement

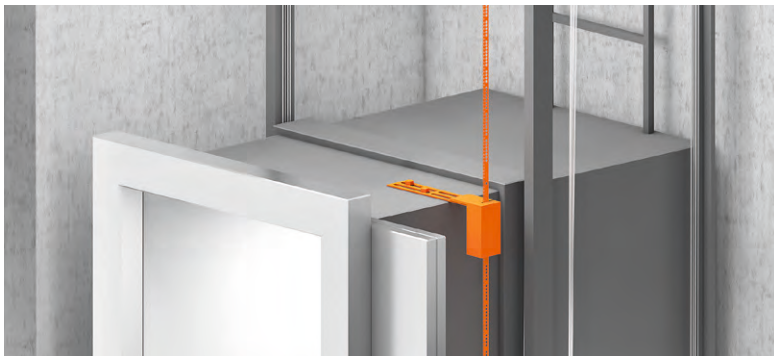

Absolute positioning with Ants shaft copying systems.

Evaluation

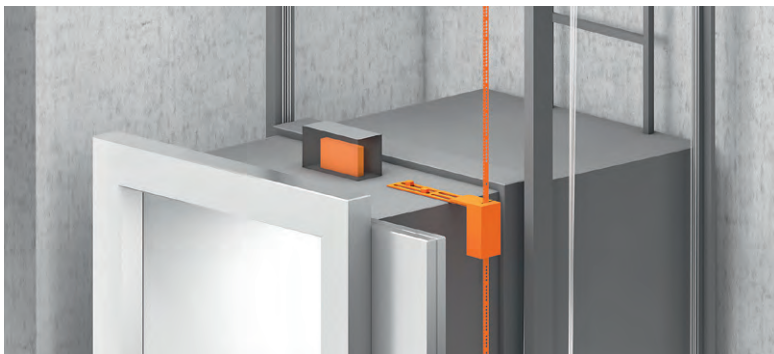

Implementation of elevator and safety functions compliant with EN 81-20/21/50 consisting of SIL3 certified sensor and evaluation unit.



Optimum control of the drive with Sendix encoders and bearingless encoders

"The right encoder for every process step". Renowned manufacturers have relied on our robust, high-resolution encoders for years. Whether for geared motors, gearless drives or pancake drives – you are guaranteed to find the right encoder for your application in our numerous ordering options.

Encoders for gearless motors

The benefits of the gearless motors are a high torque at small rotary frequencies, smooth and silent operation. Encoders for these applications must above all be flexible in terms of electrical interfaces and mounting possibilities.

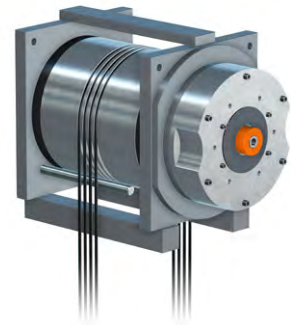

Bearingless encoders for pancake drives (external rotor motors)

The bearingless encoders are made of a magnetic ring and a sensor head. They are predestined for external rotor motors, which, thanks to their compact and flat construction, can be integrated directly in the elevator shaft. Individual adaptation of the measuring system to the dimensions of the drive are here one of the most important prerequisites.



Encoders for geared motors

In geared motors, an incremental encoder mounted between the motor and the hand wheel measures the rotational speed for speed control and transmits it to the complete drive module (CDM). These encoders feature a large hollow shaft and compact dimensions, together with a high resolution.

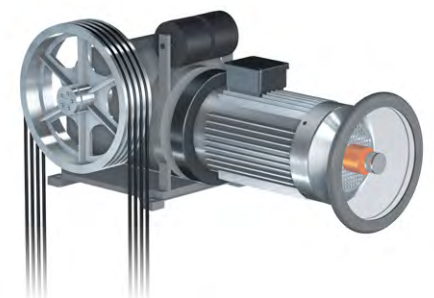

Conventional elevator system Mechanical components

In conventional elevator systems, positioning the elevator car involves a great deal of effort. Numerous mechanical components are used for this purpose, from magnetic vanes to limit switches and ramps. This results in difficult installation and high costs. The service work for these systems is not negligible. In the event of a malfunction, troubleshooting can be correspondingly time-consuming.

The high safety requirements for elevator systems are mainly realized by redundant components in this design. With the entry into force of EN 81-20/21/50, the safety requirements for passenger and freight elevators have increased even further. So the design of conventional elevator systems is becoming even more complex.

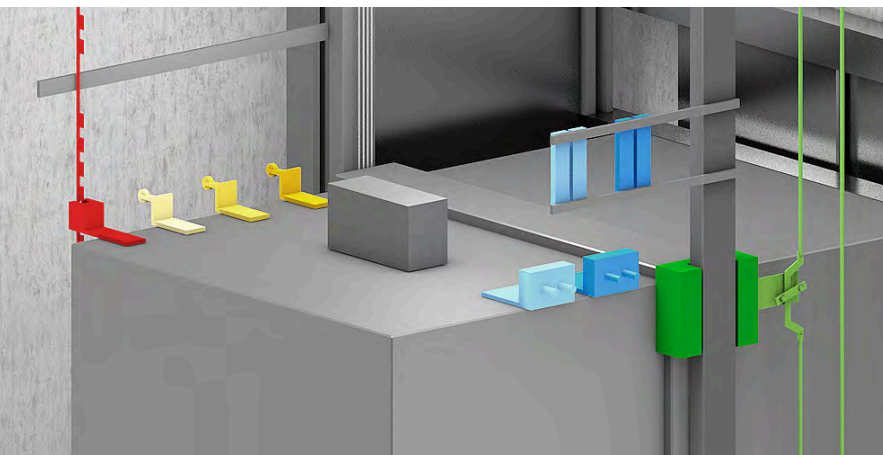

Magnetic vanes, limit switches and other components provide the necessary position references in the elevator shaft.

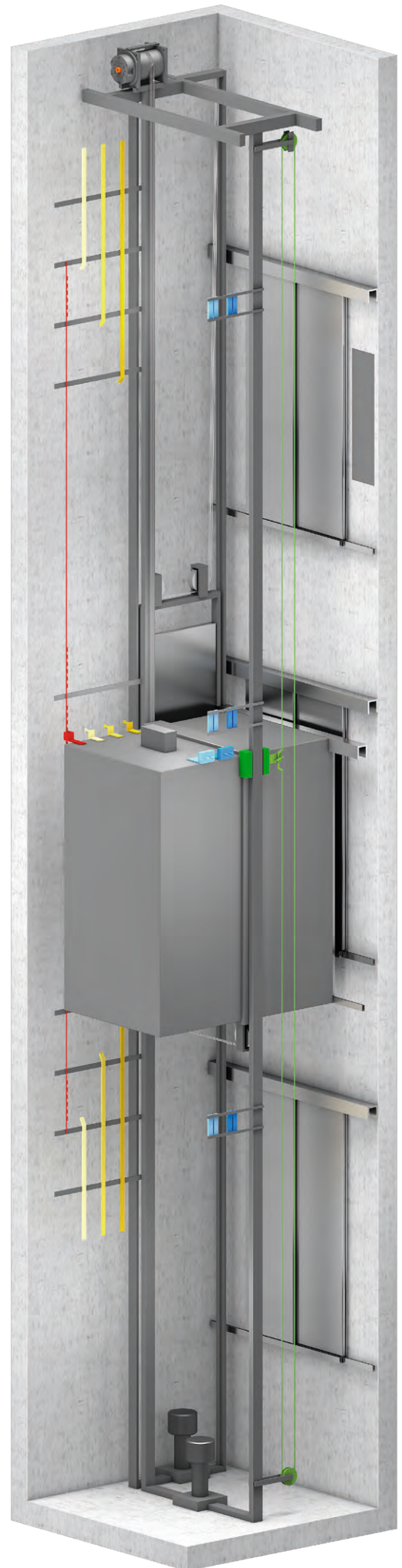

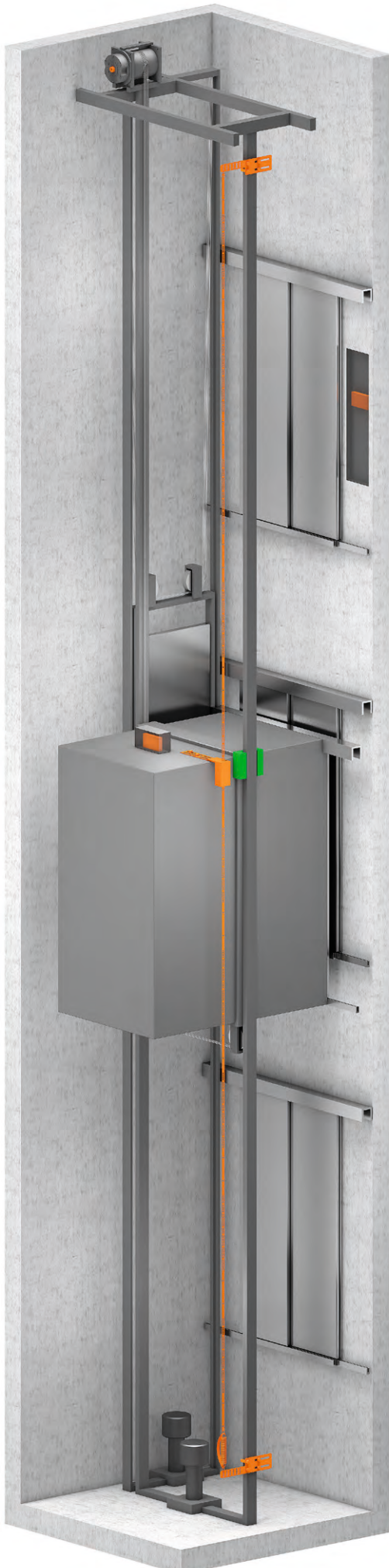

Modern elevator system Digital positioning

New technologies and products are changing the elevator industry worldwide. Thanks to SIL3-certified products, control system manufacturers and elevator manufacturers have new options for implementing elevator systems.

Digital shaft copying systems from Kübler are therefore used in modern elevator systems to position the elevator car. Mechanical components are replaced. SIL3-certified sensors in combination with SIL3-certified evaluation units (Position Supervisor Units) can also be used to implement numerous elevator and safety functions in compliance with EN 81-20/21/50.

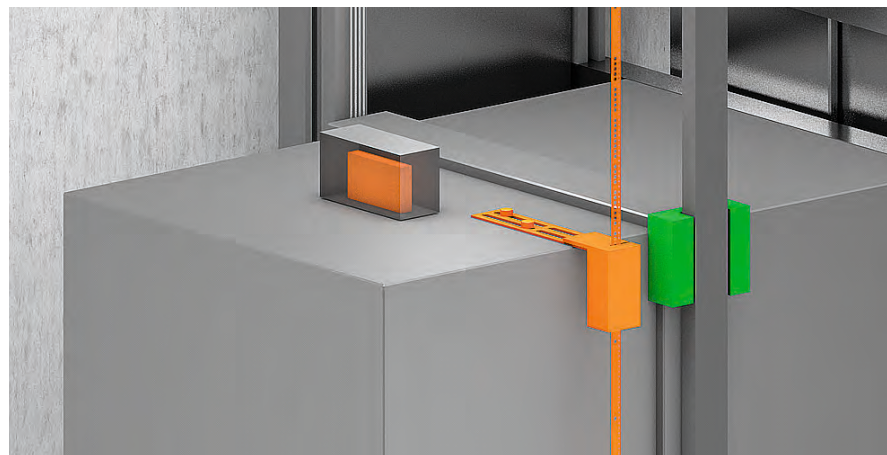

Shaft copying system with stainless steel coded band.
Control boxes with certified evaluation unit (PSU).

+ BENEFITS OF DIGITAL SHAFT COPYING SYSTEMS

- Elimination of numerous components
- Reduction in both total and service costs
- Simple, fast installation
- Implementation of elevator and safety functions in compliance with EN 81-20/21/50
- Space-saving design

Elevator and safety functions

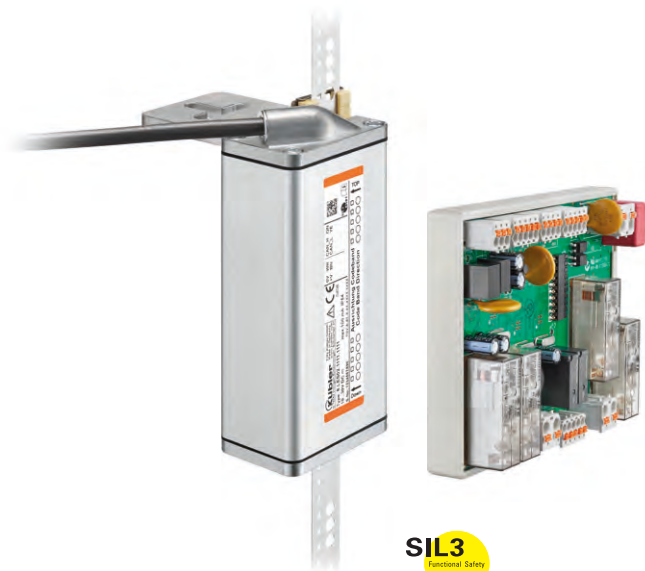

SIL3
Functional Safety
EN 81

EN 81-20/21/50

Everything from a single source: Kübler offers a complete package for functional safety technology. Based on 100% slip-free measuring, position values for the elevator car can reliably be determined by a SIL3-certified shaft copying system and transmitted to the evaluation unit (PSU).

This allows functions such as emergency limit switches, delay control, door bypass or inspection switches with shortened shaft head or shaft pit to be implemented in accordance with EN 81-21. It is also possible to implement the UCM (Unintended Car Movement) safety function. This means entirely new options for the planning and realization of elevator systems.

Overview of elevator and safety functions that can be implemented

| | References to sections of EN 81-20 / EN 81-50 / EN 81-21 | SIL according to EN 81-20 |
|---|--|---------------------------|
| Emergency limit switch | 5.12.2.3.1 b) | 1 |
| Unintended Car Movement (UCM) | 5.6.7.7 | 2 |
| Delay control (preliminary triggering) | EN 81-20 : 5.12.1.3 | 3 |
| Overspeed during teaching (1.0 m/s) | No standard reference | 3 |
| Inspection limit switch for short shaft head and pit | EN 81-21 : 5.5.3.4, 5.7.3.4 | 2 |
| Overspeed during inspection (0.6 m/s) | No standard reference | 2 |
| Overspeed (preliminary trigger +15 %) | No standard reference | Functional |
| Door bypass | EN 81-20 : 5.12.1.4 a), b), c), 2), d) | 2 |
| Two independent, redundant signals for the door zone for UCM evaluation of an additional device | EN 81-20 : 5.11.2.5 EN 81-50 : 5.6.3.1.1 | No SIL |



**UP TO THE
NEXT LEVEL**
TECHNOLOGY FOR SMART ELEVATORS

Portfolio overview – Ants shaft copying systems for travel heights up to 392 m

Depending on the implementation of the safety concepts, different options are available. The Ants Base variant is recommended for the absolute positioning of the elevator car. Here, the position values are recorded 100% slip-free.

With the Ants Safe variant, you can choose a SIL3-certified product. The Safe System variant is designed for the implementation of elevator and safety functions in accordance with EN 81-20/21/50. This consists of the Ants Safe Sensor and the evaluation unit / Position Supervisor Unit (PSU).



| | Ants Base | Ants Safe | Safe System |
|------------------|--|------------------------|---|
| Name | LEB02 | LES02 | LES02 + PSU02 |
| Measuring length | 392 m | 392 m | Sensor for 392 m 200 floors teachable |
| Speed | 8 m/s | 12 m/s | 12 m/s |
| Resolution | 1 mm | 0.5 mm | 0.5 mm |
| Interfaces | CAN, CANopen, CANopen Lift, SSI, RS485 | CAN | CANopen Lift, SSI |
| Dimensions | 126 x 55 x 37 mm | 126 x 55 x 37 mm | Sensor: 126 x 55 x 37 mm PSU: 116 x 96 x 30 mm |
| Installation | Mounting plate, T-slot | Mounting plate, T-slot | Sensor: Mounting plate, T-slot PSU: DIN rail |

The overall system at a glance

The contactless Ants shaft copying system is also known as a shaft information system or absolute positioning system.

Compact, robust, precise and simple – these are the features that make the Ants shaft copying system stand out. Whether you're upgrading existing elevators or designing new, compact systems, the digital shaft copying system from Kübler is the ideal solution.

The overall system consists of the following components:

Sensors

- SIL3-certified
- Compact design
- Robust construction
- Status LED

Coded band up to 392 m

- Stainless steel
- Absolute encoding
- Rounded edges

Mounting kit

- Rail mounting using slots
- Suitable for common elevator rails
- Stainless steel snap hooks
- High-quality tension springs
- Securing band (Ants Safe only)
- Car mounting for optimum sensor adjustment

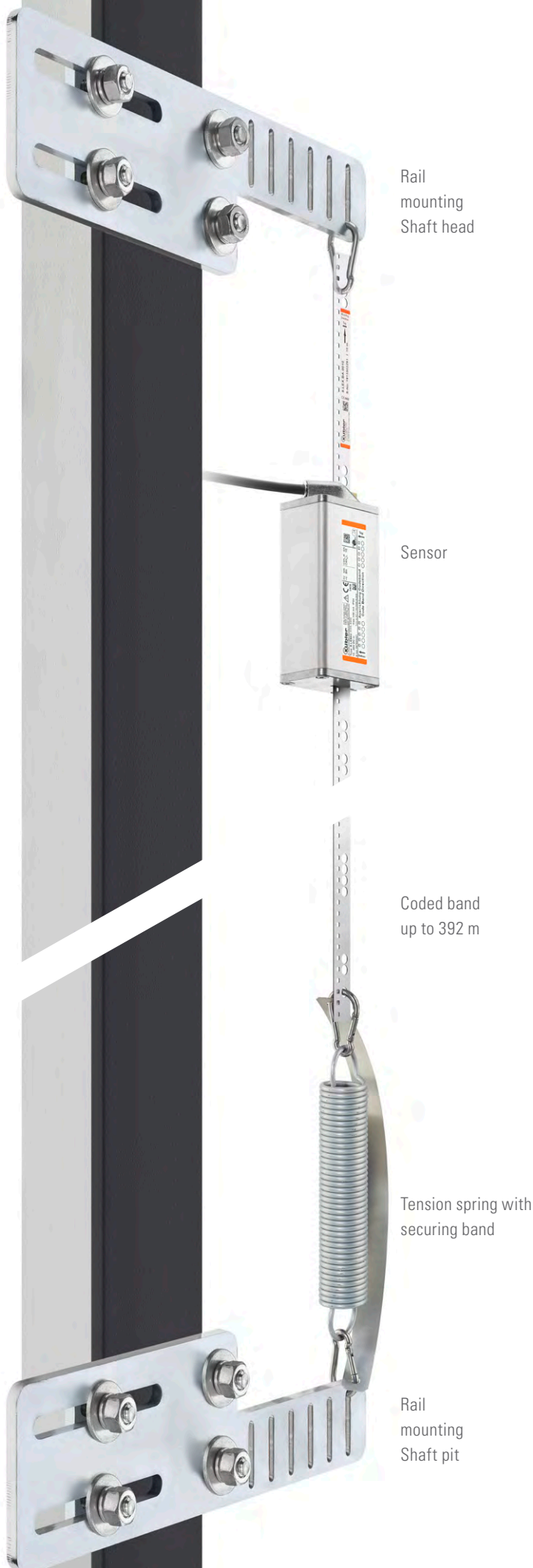

Figure shows
Ants Safe variant

Time and cost savings over the entire length

Overview of individual assembly steps

Installing a digital shaft copying system in elevator shafts has never been this easy. In contrast to conventional systems on the market, installation is child's play. For error-free and fast assembly, the Ants shaft copying systems mounting kit includes all the parts you need. Its simple assembly and compact design are already a hit with elevator builders and fitters worldwide.



1 Mount the rail mounting in the shaft head.



2 Use the snap hook to hang the coded band into the slot of the rail mounting. Be careful with the lateral alignment of the holes in the coded band. Follow the illustration on the name plate of the sensor. Follow the installation instructions on the coded band packaging (in 6 languages). The coded band unrolls from its cardboard packaging during downward travel.

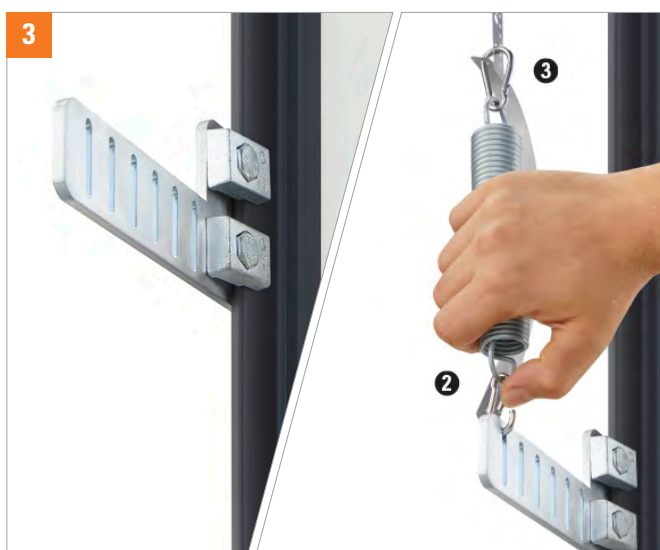

3 At the shaft pit: Fit the rail mounting. Hook the tension spring and securing band into the snap nook and connect to the rail mounting (same slot as in shaft head). Cut coded band to length and use the snap hook to connect it to the tension spring and securing band.



4 Maximum flexibility: Connect sensor to the car mounting and adjust optimally (three possible mounting types in 90° steps). Maximum compactness: Whether with mounting plate or T-slot, the system is suitable for the narrowest installation spaces.



5 Connect the sensor to the coded band: To do this, remove the outer sliding strip. Insert the coded band into the housing slot, and pay attention to the alignment of the large and small holes (the correct alignment can be read off the name plate). Insert the sliding strip back into the sensor. Align sensor optimally (without pressure on sliding strips) and fix to cabin mounting. The coded band is now guided optimally by the two sliding strips.

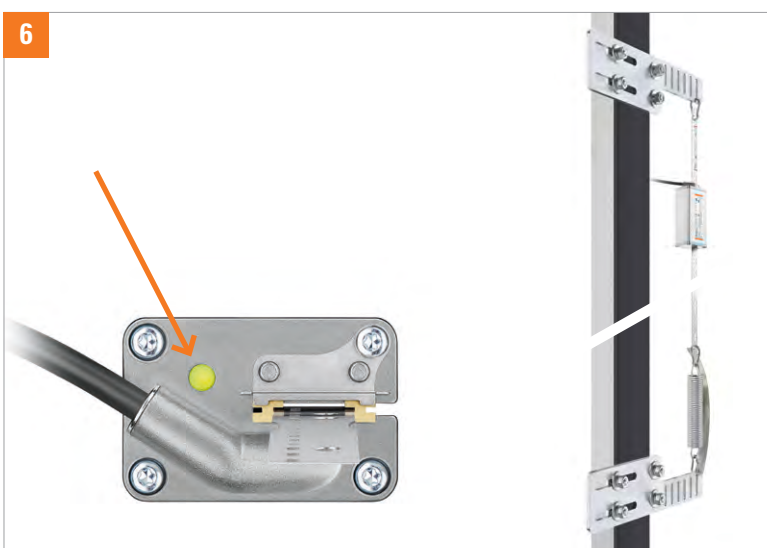

6 The overall system is installed and ready to operate. The status LED provided visual support during installation and maintenance.

Figure shows Ants Safe variant

Your benefits with Ants shaft copying systems

+ Time and cost savings during assembly

One of Kübler's unique selling points is its ease of mounting. Snap hooks can be used to attach the stainless steel band to the different mounting sets in a very simple "plug and play" procedure. In the shaft pit, the belt is pretensioned by a spring. The essential installation instructions are available both on the strip packaging and directly on the sensor. No more time-consuming scrolling through user manuals or searching of PDF files.

+ Reliable and durable

The robust stainless steel band with its rounded edges is mounted directly to the guide rails using a mounting set. It can neither be influenced by temperature fluctuations nor by magnetic influences during mounting, such as the use of magnetized screwdrivers. The code is punched into the stainless steel strip. As a result, Kübler dispenses with additional gluing processes and thus ensures maximum robustness of the band in the application.

+ Suitable for the tightest installation spaces

The extremely compact design not only saves space but also costs. Especially for elevators with reduced shaft head, shaft copying from Kübler offers benefits. Sensors can be mounted on, next to or under the cabin.

+ Reduction of overall costs

With the SIL3 certified Position Supervisor Unit (PSU), evaluation unit, or Safe Box, elevator and safety functions can be realized in accordance with EN 81-20/21/50. These include emergency limit switches, UCM (Unintended Car Movement), inspection limit switches, overspeed inspection, or door bypass. Kübler's safe system allows numerous existing components in the elevator shaft to be eliminated, such as limit switches, magnetic vanes, reference switches, or door zone magnets. In addition to procurement costs, this saves installation and maintenance time.

+ Precise positioning

Loss of absolute position or correction of position by reference switches (magnetic vanes) are a thing of the past. With Kübler's shaft copying, the position of the elevator car can be determined 100% slip-free. The sensor is mounted directly on the elevator car and can determine the absolute position without additional reference markers in the shaft. Slippage of the cable at the drive has no effect on the measuring result. The sensor system is an absolute value system which can record a unique absolute position value at any point of the coded band.



Ritzler www.ritzler.com
560 300 0000
560 300 0000

CE EN 60088-2
CAV.H GN
CAV.L YE
M.V. BN
CAV.L YE

00000 Ausrichtung Codeband
00000 Code Band Direction

00000

00000

00000

Encoders for gearless drives

Permanent magnet excited gearless synchronous drives (gearless drives) are the consistent further development of geared motors. Their benefits are primarily a high torque even at small rotary frequencies, as well as uniform and silent operating properties. Gearless drives are therefore perfectly suited for use in the elevator technology.

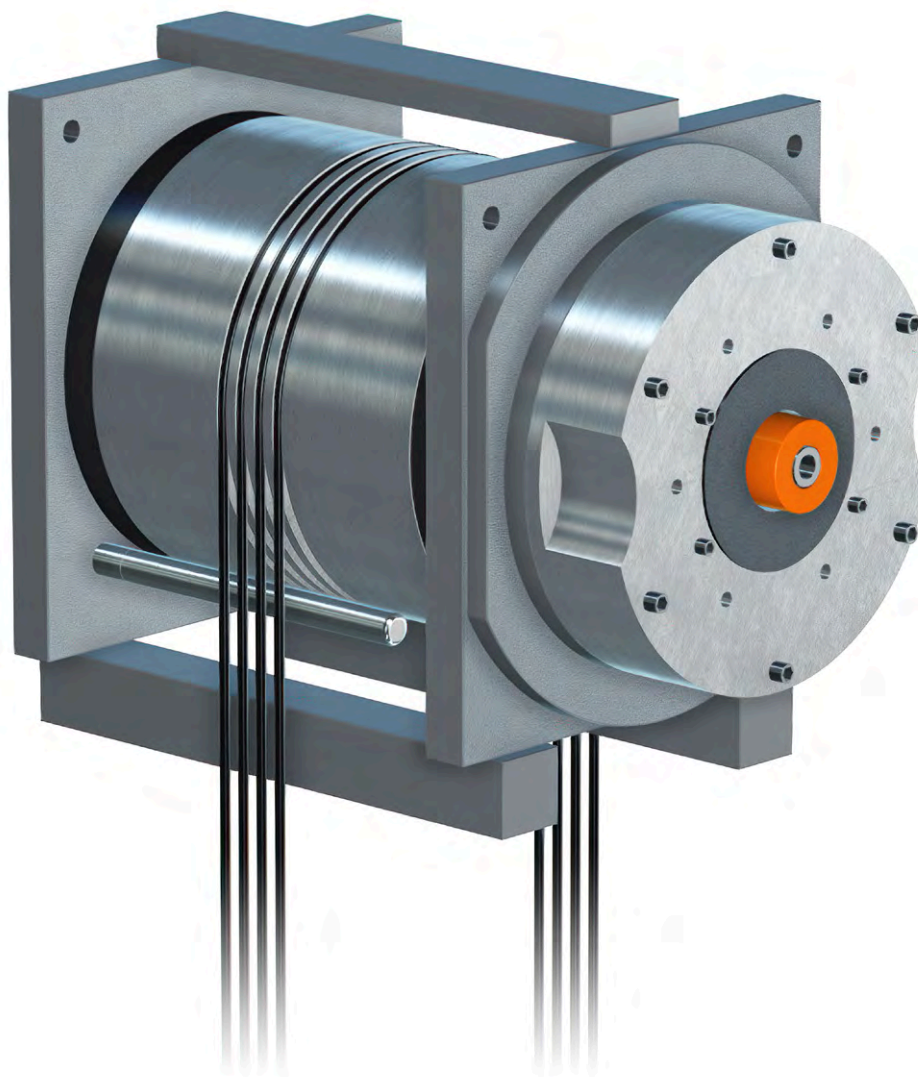

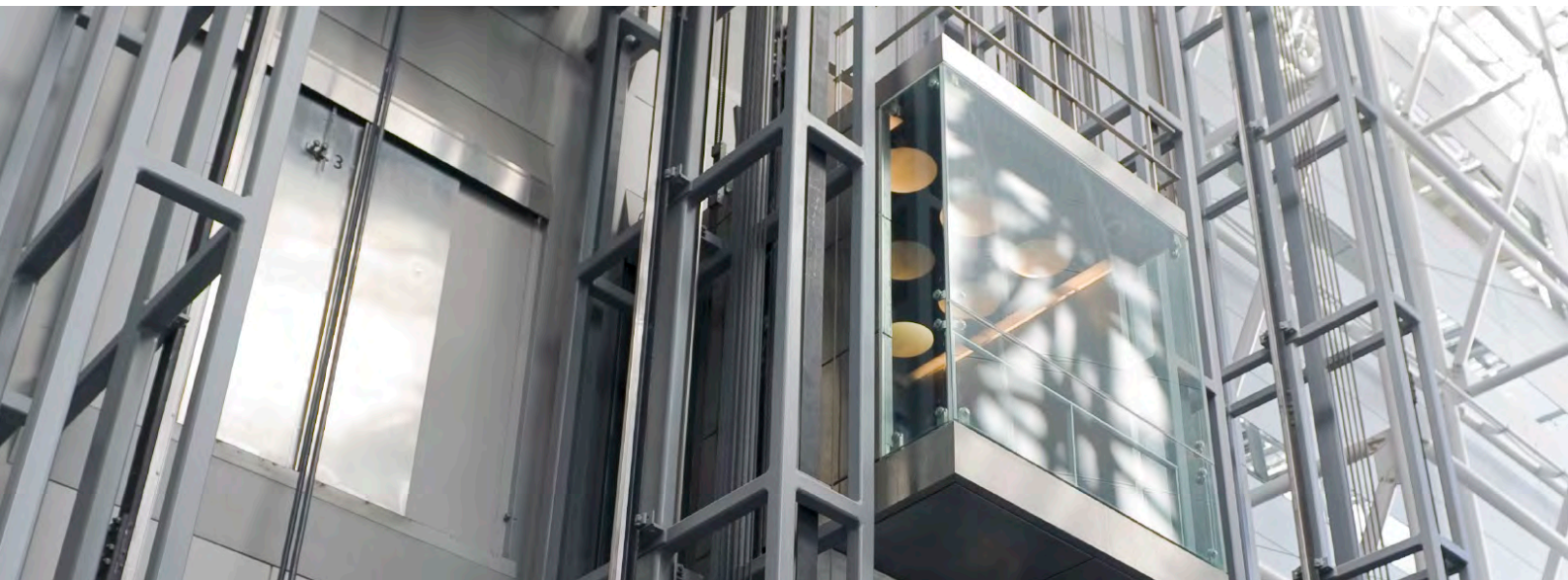

Encoders for gearless drives

Flexibility is the main characteristic of the encoders for gearless drives.

They provide the suitable encoder technology, the optimal mechanical mounting, but also the electrical interface.

The drive and/or the system determine the choice of the suitable encoder.



| | Sendix 5873 Motor-Line | Sendix 5834 Motor-Line |
|----------------------|---|---|
| General information | Absolute encoder with tapered shaft and robust bearing structure in Safety-Lock™ design | Incremental encoders with tapered shaft and robust bearing structure in Safety-Lock™ design |
| Mechanical interface | Tapered shaft 10 mm with stator coupling ø 72 mm or with expanding coupling ø 65 mm | Tapered shaft 10 mm with stator coupling ø 72 mm or with expanding coupling ø 65 mm |
| Electrical interface | Absolute SSI / BiSS incremental SinCos | Incremental SinCos |
| Size | ø 58 mm | ø 58 mm |
| Resolution max. | 13 bit or 17 bit + 2048 ppr SinCos optional: 21 bit, fully-digital | 1024, 2048 ppr SinCos |
| Speed max. | 12000 min ⁻¹ | 12000 min ⁻¹ |
| Temperature range | -40°C ... +105°C | -40°C ... +90°C |
| Power supply | 5 V DC 4,5 ... 5,5 V DC 10 ... 30 V DC | 5 V DC 10 ... 30 V DC |

i PCB connector

The Sendix 5873 and Sendix 5834 encoders in Motor-Line version are also available with a PCB connector instead of the cable connection.



Encoders for gearless drives

High-resolution singleturn encoder Sendix 5873 Motor-Line

The Sendix 5873 singleturn encoders with SSI or BiSS interface and optional 2048 ppr SinCos signals are predestined for the elevator technology. Furthermore, the Sendix 5873 in Motor-Line version convince with their plug-and-play commissioning including an electronic data sheet and the possibility of setting the absolute measuring system to a predefined position (electronic zeroing).



Your benefits at a glance

- High-resolution singleturn encoder for optimal travel comfort
- Predestined for the elevator technology thanks to its design optimized for gearless drives
- Cost-efficient thanks to simple plug-and-play commissioning
- Reduction of life cycle costs due to the optimization of drive efficiency thanks to the high-resolution absolute and analog encoder signals
- Reduction of the energy costs thanks to the electronic switching based on the high-resolution absolute position information of the measuring system

Characteristics

Resolution

- SSI with max. 17 bit singleturn resolution and additional 2048 SinCos signals
- BiSS interface with max. 21 bit singleturn resolution and additional 2048 SinCos signals

Electrical interface

- BiSS or SSI interface with additional SinCos signals
- Electronic data sheet
- Possibility of setting the measuring system to a predefined position value (electronic zeroing)
- Optional SET key – to zero the Sendix 5873 Motor-Line at any desired position

Mechanical interface

- Tapered shaft with stator coupling, \varnothing 72 mm or tapered shaft with expanding coupling, \varnothing 65 mm
- Tangential cable outlet or PCB connector
- Robust bearing structure in Safety-Lock™ Design

Order code
Tapered shaft

8.5873 . **XKXX** . **XX2X**
Type a b c d e f g

a Flange

G = with stator coupling, IP65, \varnothing 72 mm [2.83"]
H = with expanding coupling, IP65, \varnothing 65 mm [2.56"]

b Tapered shaft

K = \varnothing 10 mm [0.39"]

c Interface / power supply

1 = SSI, BiSS / 5 V DC
2 = SSI, BiSS / 10 ... 30 V DC
3 = SSI, BiSS + 2048 ppr. SinCos / 5 V DC
4 = SSI, BiSS + 2048 ppr. SinCos / 10 ... 30 V DC
5 = SSI, BiSS / 5 V DC, with sensor output
6 = SSI, BiSS + 2048 ppr. SinCos / 5 V DC, with sensor output
9 = SSI, BiSS + 2048 ppr. RS422 (TTL-comp.) / 5 V DC, with sensor output
E = SSI, BiSS + 2048 ppr. SinCos / 4.5 ... 5.5 V DC, with sensor output¹⁾

d Type of connection

E = tangential cable, 1 m PVC
F = tangential cable, length PVC see below *)
G = tangential cable, with Sub-D connector (male contact, 15-pin, double-row), length PVC s. below *)²⁾
H = tangential cable, with Phoenix Contact connector (MC1.5/16-STF-3.81), length PVC s. below *)²⁾
L = with PCB connector³⁾
(without cable, including sealing cap for tangential cable outlet)

*) Available lengths (connection types F, G, H):
2, 3, 5, 8, 10, 15 m [5.56, 9.84, 16.40, 26.25, 32.80, 49.21']
order code expansion .XXXX = length in dm
ex.: 8.5873.GK2E.G323.0030 (for cable length 3 m)

e Code

B = SSI, binary
C = BiSS, binary
G = SSI, gray

f Resolution⁴⁾

A = 10 bit
1 = 11 bit
2 = 12 bit
3 = 13 bit
4 = 14 bit
7 = 17 bit
C = 21 bit⁵⁾

g Options (service)

1 = no option
2 = status LED
3 = SET button and status LED

- 1) Without reverse polarity protection.
2) Can be combined as a standard only with interface E (other variants on request).
3) IP40, only available without SET button and status LED, not available with interface 9, see the Accessories for the suitable connection cable.
4) Resolution, preset value and counting direction factory-programmable.
5) Only in conjunction with interface 1 or 2 and code C.

Solutions for the ideal connection of motor, encoder and CDM – Complete Drive Module

The Sendix 5873 singleturn encoders in Motor-Line version provide above all high flexibility. This means that focus is set on the solution itself in order to achieve an ideal connection between the motor, the encoder and the CDM – Complete Drive Module. This ensures maximum customer benefit and highest flexibility.

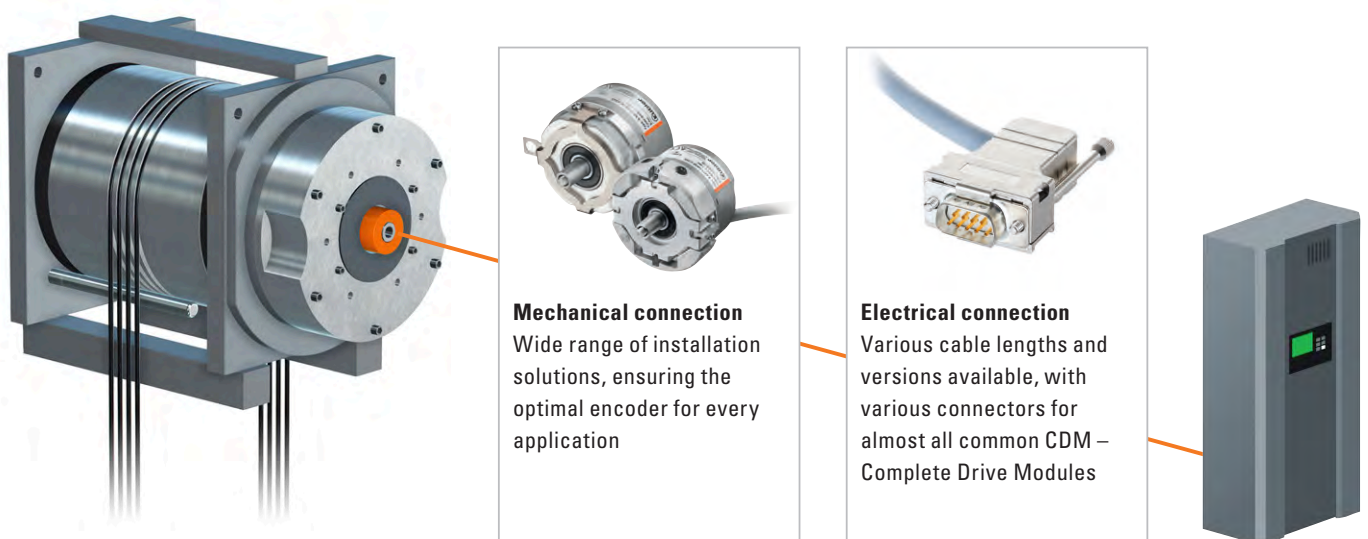

Bearingless encoders for pancake drives

Axial flux synchronous drives or pancake drives are characterized in various versions by a compact and particularly flat construction.

Generally, these drives do not require an additional machinery room and are installed directly in the elevator shaft.

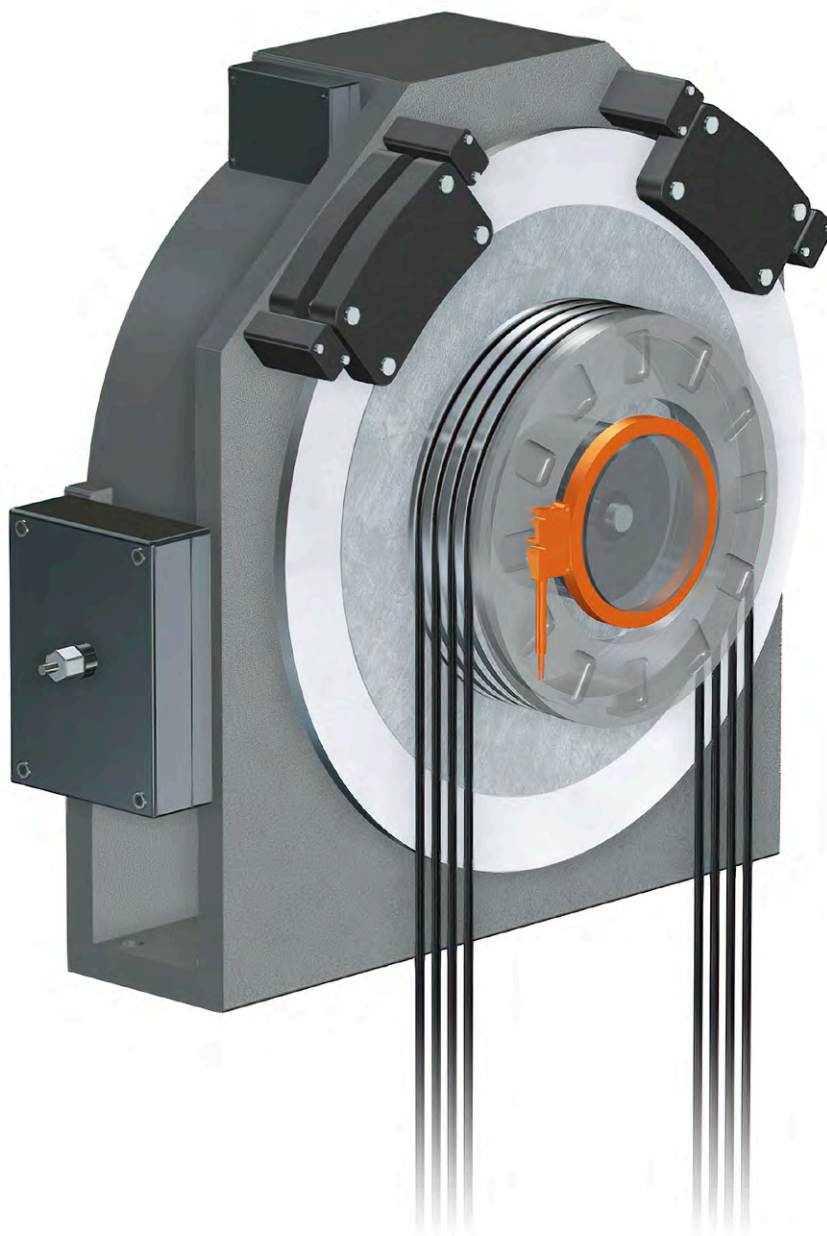



Bearingless encoders for pancake drives

The bearingless encoders are made of a magnetic ring and a sensor head. They are ideal for compact and flat external rotor motors. The non-contact measuring principle, with its reduced mounting depth and various magnetic ring diameters, is perfectly suited for tight installation possibilities. Individual adaptation of the measuring system to the dimensions of the drive are here one of the most important prerequisites.

| | RLI500, RLI200, RLI50, RLI20 |
|----------------------|--|
| General information | Bearingless encoder for tightest mounting situations (only 10 mm deep) |
| Ring diameter | On request (customer-specific) |
| Electrical interface | Push-pull, RS422 SinCos |
| Size | 40 x 25 mm (sensor head) |
| Resolution max. | On request (resolution depends on ring diameter) |
| Speed max. | 12000 min ⁻¹ |
| Temperature range | -20 °C ... +80 °C |
| Power supply | 4.8 ... 26 V DC (RS422) 4.8 ... 30 V DC (Push-Pull) |

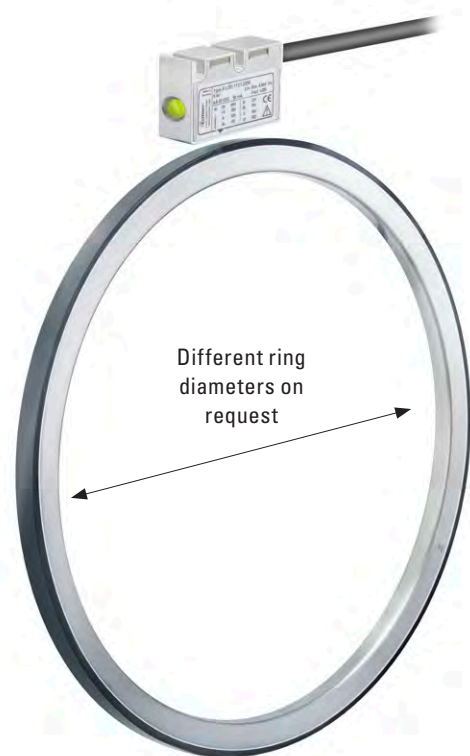

Encoders for geared motors

Geared motors are used for the new construction, but mainly for the modernization of elevator systems. Their main features are the reduction gear and a handwheel at the end of the motor shaft. On these drives, an incremental encoder mounted between the motor and the handwheel measures the rotary speed for speed control and transmits it to the CDM – Complete Drive Module.

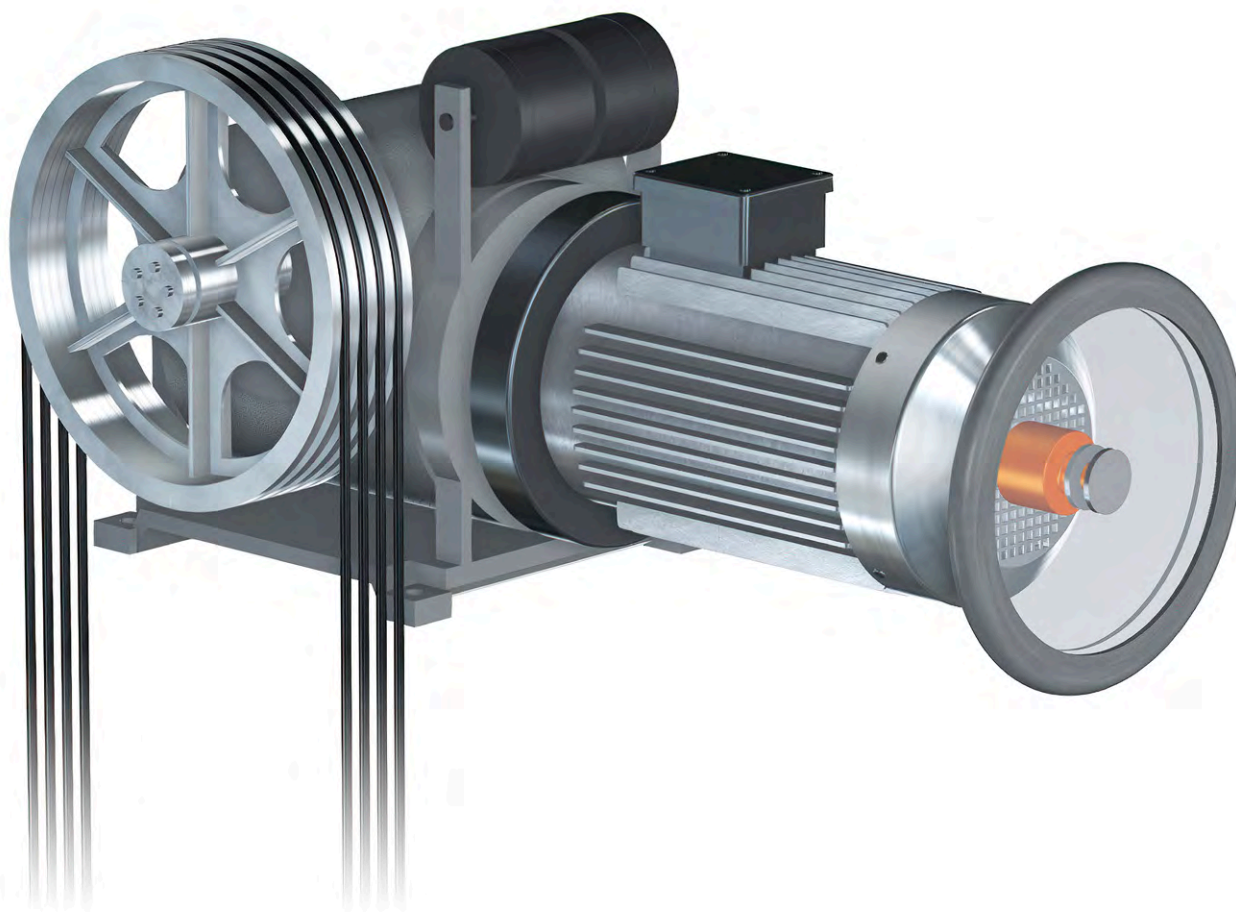



Encoders for geared motors

The encoders for geared motors are characterized in particular by their large hollow shaft and their compact size intended for tight mounting spaces. In addition, high encoder resolution is necessary in order to ensure optimum speed regulation.



| | 5821 | A020 / A02H |
|----------------------|--|---|
| General information | Compact encoder for large smoothly-operating drives and tight mounting space | Tight mounting conditions and applications with high bearing forces |
| Mechanical interface | Hollow shaft max. 28 mm | Hollow shaft max. 42 mm |
| Electrical interface | Push-pull, RS422 | Push-pull, RS422, SinCos |
| Size | ø 58 mm | ø 100 mm |
| Resolution max. | 5000 ppr | 5000 ppr |
| Speed max. | 2500 min ⁻¹ | 6000 min ⁻¹ |
| Temperature range | -20°C ... +70°C | -40°C ... +80°C |
| Power supply | 5 V DC 8 ... 30 V DC | 5 V DC 5 ... 30 V DC 10 ... 30 V DC |

Overview electrical interfaces

Encoders have various tasks to fulfil in elevator engineering. One of the most frequent tasks is to supply information concerning speed, for better control of the motor using a CDM – Complete Drive Module. For this type of speed control motor feedback is necessary, which is suitable for improving the speed quality and the control response. As a rule a SinCos or TTL / HTL signal is used for this purpose. A further task is the positioning of the drive. This can occur both incrementally and absolutely. The dynamic control of synchronous servo motors requires the feedback of the rotor position within a revolution. This is achieved using singleturn absolute encoders with a BiSS or SSI interface.

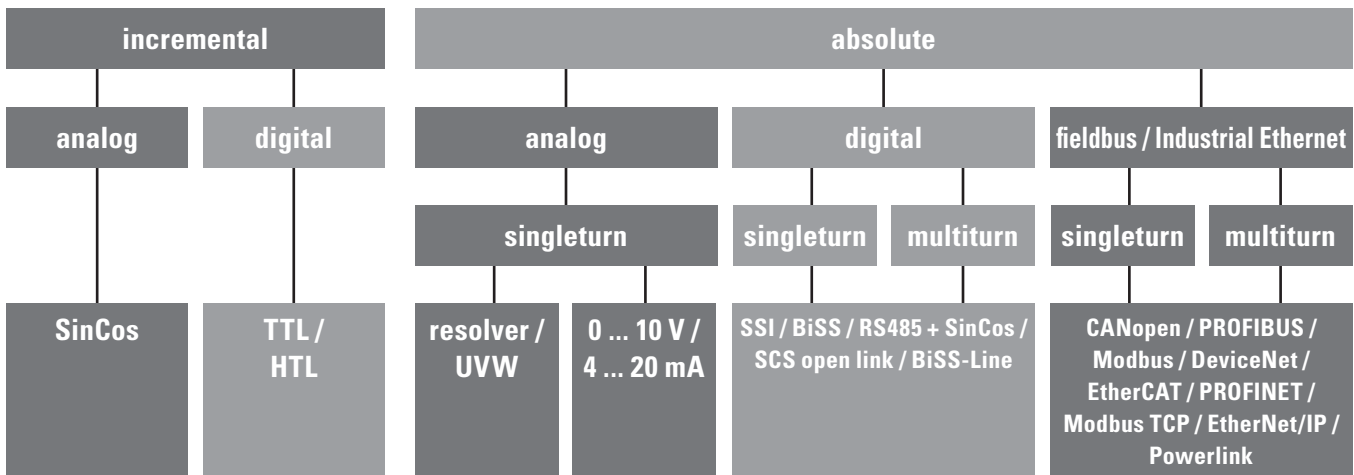

Single Cable Solutions

The Single Cable Solutions combines the motor power supply line and the data communication in one single cable. Requiring less cables and connectors, this technology simplifies installation and thus reduces in the same time the error sources. Not all protocols are suitable. They must be specially tailored to this application, such as for example SCS open link or BiSS Line.

Safety is not simply a trend, but it is establishing itself as a standard in the drive technology. It is therefore important to pay attention to safety-relevant characteristics when choosing the interface.

Field buses or industrial Ethernet interfaces are principally used in the application and are not directly involved in speed regulation. The position control can operate with these encoders.



Incremental interface (SinCos, TTL / HTL)

The SinCos interface provides a sine wave-shaped voltage signal. High-quality encoders allow very high interpolation of this signal, which benefits the speed control. This means that the SinCos signals can be processed in many various ways in the subsequent electronics. The steady signal evolution makes sure that signal information is available at any time. This is a benefit in drives for speed control, even for very slow motions.

The cosine precedes the sine by 90° so that one of the signals emits a valid value also when passing the zero point. This is also the great difference with digital incremental signals such as HTL or TTL. These have signal states in which both channels A and B can have simultaneously the value zero or one, which does not allow detecting errors.

By contrast, even though the encoders with incremental interface (TTL / HTL) also generate a sine wave shaped scanning signal, this signal is then digitized in the encoder and provided to the subsequent electronics as a rectangular pulse.

Various output types are available for transmission.

SSI interface

The synchronous serial interface (SSI) is a digital interface for absolute motion and angle measuring systems. This means that the SSI interface allows digital and absolute transmission of motion or angular information. It is therefore particularly well suited for applications requiring reliability and signal robustness in industrial environments. Another benefit is the fact that transmission requires significantly less lines than parallel interfaces. It also allows much longer cable lengths.

At rest, the clock and data lines are at a high level. With the first falling clock-pulse edge, the current encoder data are stored in the buffer ready to be sent. With the next rising clock-pulse edge, the data are transmitted bit by bit, starting with the MSB.

The transfer of a complete data word requires n+1 rising clockpulse edges (n=resolution in bit), e.g. 14 clock signals for a complete readout of a 13 bit encoder. After the last positive going clock-pulse edge the data line will remain for the duration of the monoflop time t3 at a low level, until the encoder is ready for a new data word. The clock line must stay high for at least as long, and then can begin a new readout sequence again with the next falling edge.

Product portfolio – Made in Germany



MEASUREMENT

Rotary speed and position detection, linear position, and speed measurement as well as inclination angle detection.

- Encoders
- Bearingless encoders
- Motor Feedback Systems
- Linear measuring systems
- Shaft copying systems
- Inclinometers

TRANSMISSION

Reliable and interference-free transmission of power, signals, and data. Communication between control system and sensors.

- Slip rings
- Slip rings, customized solutions
- Signal converters and optical fiber modules
- Cables and connectors

EVALUATION

Recording of quantities, counting of units of any kind, and reliable speed and position recording for functional safety.

- Displays and counters
- Process devices
- Safe speed monitors up to SIL3/PLe

We offer solutions for the following industries:

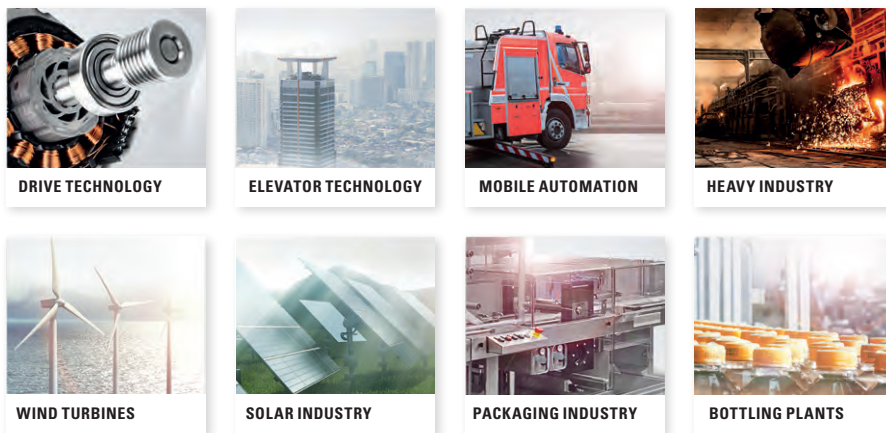

The high performance level and reliability of the Kübler products are based on our long experience in these demanding application sectors. Learn more about our application-specific solutions under:

kuebler.com/industries

Kübler Service for worldwide planning reliability

24one **24one delivery promise**
Manufacturing in 24 hours. For orders placed on working days before 9 AM, the product will be ready for dispatch on that same day. 24one is limited to 20 pieces per delivery.

10 by 10
We will manufacture and deliver 10 encoders within 10 working days (365 days a year - with the exception of 24th Dec. until 2nd Jan.)

48 h **48 h Express-Service**
We can process your order within 48 hours; we can ship stock items the same day.

Technical Support
Kübler' application team is present on site all over the world for advice, analysis and support.

| | |
|----------------------|-------------------|
| Kübler Germany | +49 7720 3903 952 |
| Kübler France | +33 3 89 53 45 45 |
| Kübler Italy | +39 026 423 345 |
| Kübler Poland | +48 61 84 99 902 |
| Kübler Austria | +43 3322 43723 12 |

Sample Service
We manufacture samples of special designs or according to customer specification within shortest time.

FS **Safety Services**
Individual customer solutions.

KDS **Tailor-made Solutions – Kübler Design System (KDS) OEM Products and Systems (OPS)**
We develop jointly with our customers product and engineering solutions for customer-specific products, integrated drive solutions, up to complete systems.



KÜBLER WORLDWIDE

500 EMPLOYEES · 4 PRODUCTION SITES · PRESENCE IN OVER 50 COUNTRIES

EUROPE AUSTRIA · BELARUS · BELGIUM · BULGARIA · CROATIA · CZECH REPUBLIC · DENMARK · ESTONIA · FINLAND · FRANCE · GERMANY · GREAT BRITAIN · GREECE · HUNGARY · ICELAND · IRELAND · LITHUANIA · ITALY · NETHERLANDS · NORWAY · POLAND · PORTUGAL · SLOVAKIA · SLOVENIA · SPAIN · SWEDEN · SWITZERLAND · TURKEY · UKRAINE
AFRICA ÄGYPT · MOROCCO · SOUTH AFRICA · TUNISIA **NORTH AND SOUTH AMERICA** ARGENTINA · BRAZIL · CANADA · MEXICO · PERU · U.S.A.
OCEANIA AUSTRALIA · NEW ZEALAND **ASIA** CHINA · HONG KONG, CHINA · INDIA · INDONESIA · ISRAEL · LEBANON · MALAYSIA · PHILIPPINES · SINGAPORE · SOUTH KOREA · TAIWAN, CHINA · THAILAND · UNITED ARAB EMIRATES · VIETNAM

KÜBLER GROUP

-  FRITZ KÜBLER GMBH
-  FRITZ KÜBLER SARL
-  KÜBLER ITALIA S.R.L.
-  KÜBLER ÖSTERREICH
-  KÜBLER SP. Z.O.O.
-  KÜBLER TURKEY OTOMASYON TICARET LTD. STI.
-  KÜBLER INC.
-  KÜBLER AUTOMATION INDIA PVT. LTD.
-  KUEBLER (BEIJING) AUTOMATION TRADING CO. LTD.
-  KUEBLER KOREA (BY F&B)
-  KÜBLER AUTOMATION SOUTH EAST ASIA SDN. BHD.
-  KUEBLER PTY LTD

Kübler Group

Fritz Kübler GmbH

Schubertstrasse 47
78054 Villingen-Schwenningen
Germany

Phone +49 7720 3903-0
Fax +49 7720 21564
info@kuebler.com

kuebler.com